

KRAFTWERK®

FAVORITE TOOLS SINCE 1979

Modular Workshop Equipment System 2024

Valid from 01.02.2024 to 31.01.2025

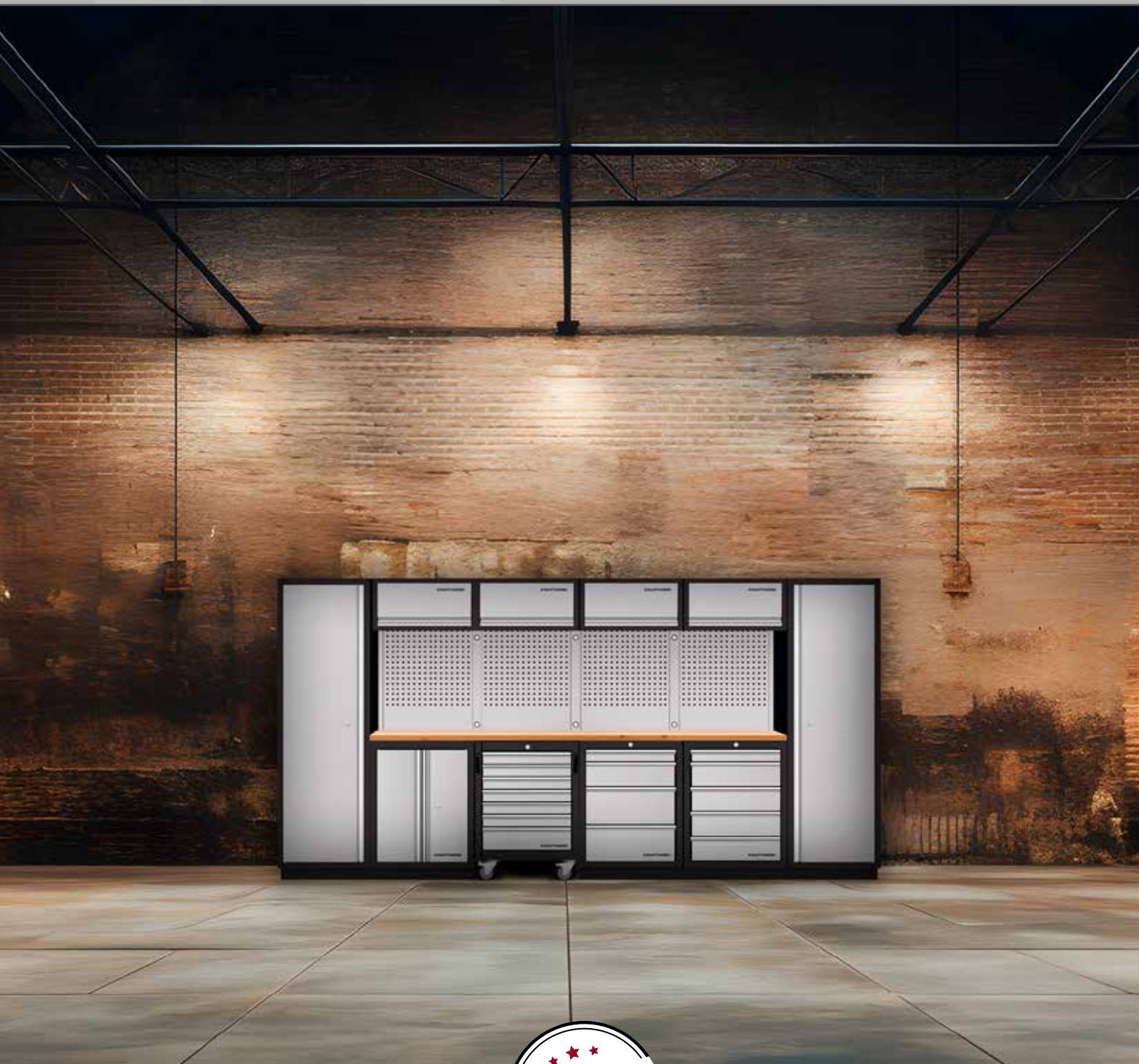



KRAFTWERK is a **Swiss company** that manufactures high-quality hand tools, workshop carts, and workshop equipment. Since 1979, this family-owned business has been successful in attractive segments such as automotive, agriculture, construction, and industry, as well as hobby craftsmanship.

The **Mobilo workshop equipment from Kraftwerk offers a high-quality solution that meets the individual needs** of our customers in every aspect. Whether you're a hobbyist or a professional craftsman, with the Mobilo workshop, you have the opportunity to optimize your work environment and work efficiently.

Our Mobilo workshop equipment is a **modular system** that can be assembled according to your requirements. From the depth of workbenches to the material, module combinations, and inserts – you have full control.

Our **online 3D web configurator** allows you to easily plan your desired workshop from home or at the dealer. With this interactive tool, you can visualize and create your preferred workshop.

Through **innovative and sustainable products, KRAFTWERK aims to provide the best solution for every requirement** and secure its success in the long term. The corporate values of KRAFTWERK place great emphasis on partnerships and customer satisfaction. The company strives to develop tools that become every craftsman's favorite.

The company will continue to **develop and produce innovative solutions** to further expand its position in the tool industry.

Welcome to Mobilio Deep The innovative solution for your workshop!



Kraftwerk proudly presents **the latest development/expansion**, available since the end of 2023: **deep work surfaces** for a more personalized/flexible Mobilio workshop.

These new work surfaces, made of high-quality beech wood, provide the user with **the decisive advantage of a deeper workspace**.

With **dimensions** of H 2000 x W x **D 696 mm**, they create a **spacious and comfortable working environment**.

The easy assembly is effortlessly done in combination with standard base cabinets through the use of extension brackets.

Discover the **various combination possibilities** presented in our brochure and **optimize your workflows** with Mobilio Deep!

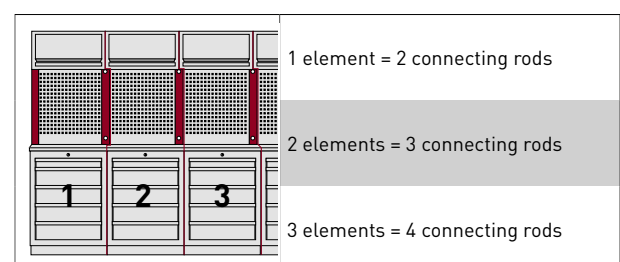
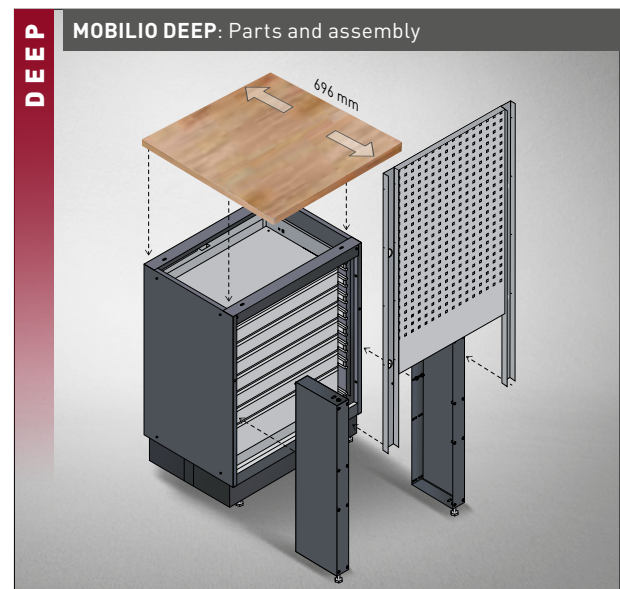

Configured Elements I empty

Combinations also available with deep worktops

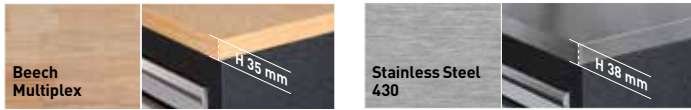

+ H 2000 x W 1960 x D 488 mm
+ H 2000 x W 1960 x D 721 mm - **NEW**

| Art. | Worktop | Depth |
|---------------------|---------------------|--------|
| 3964A | Beech Multiplex | 463 mm |
| 3964AIX | Stainless Steel 430 | 463 mm |
| NEW 3964A-EX | Beech Multiplex | 696 mm |



+ H 2000 x W 2640 x D 488 mm
+ H 2000 x W 2640 x D 721 mm - **NEW**

| Art. | Worktop | Depth |
|---------------------|---------------------|--------|
| 3964B | Beech Multiplex | 463 mm |
| 3964BIX | Stainless Steel 430 | 463 mm |
| NEW 3964B-EX | Beech Multiplex | 696 mm |

| Art. | Worktop | Depth |
|--------------------------|---------------------|--------|
| 3964K-854S | Beech Multiplex | 463 mm |
| 3964K-854SIX | Stainless Steel 430 | 463 mm |
| NEW 3964K-854S-EX | Beech Multiplex | 696 mm |



+ H 910 x W 2720 x D 458 mm
+ H 910 x W 2720 x D 721 mm - **NEW**



+ H 2000 x W 2955 x D 488 mm
+ H 2000 x W 2955 x D 721 mm - **NEW**

| Art. | Worktop | Depth |
|---------------------|---------------------|--------|
| 3964D | Beech Multiplex | 463 mm |
| 3964DIX | Stainless Steel 430 | 463 mm |
| NEW 3964D-EX | Beech Multiplex | 696 mm |



+ H 2000 x W 2955 x D 488 mm
+ H 2000 x W 2955 x D 721 mm - **NEW**

| Art. | Worktop | Depth |
|---------------------|---------------------|--------|
| 3964G | Beech Multiplex | 463 mm |
| 3964GIX | Stainless Steel 430 | 463 mm |
| NEW 3964G-EX | Beech Multiplex | 696 mm |



| Art. | Worktop | Depth |
|---------------------|---------------------|--------|
| 3964C | Beech Multiplex | 463 mm |
| 3964CIX | Stainless Steel 430 | 463 mm |
| NEW 3964C-EX | Beech Multiplex | 696 mm |

+ H 2000 x B 3920 x T 488 mm
 + H 2000 x B 3920 x T 721 mm - **NEW**



| Art. | Worktop | Depth |
|-------------------------------|---------------------|--------|
| 3964K-HS745H-K4 | Beech Multiplex | 463 mm |
| 3964K-HS745H-K4IX | Stainless Steel 430 | 463 mm |
| NEW 3964K-HS745H-K4-EX | Beech Multiplex | 696 mm |

+ H 2000 x B 3920 x T 488 mm
 + H 2000 x B 3920 x T 721 mm - **NEW**



| Art. | Worktop | Depth |
|---------------------|---------------------|--------|
| 3964F | Beech Multiplex | 463 mm |
| 3964FIX | Stainless Steel 430 | 463 mm |
| NEW 3964F-EX | Beech Multiplex | 696 mm |

+ H 2000 x B 3920 x T 488 mm
 + H 2000 x B 3920 x T 721 mm - **NEW**

Configurated Elements I empty

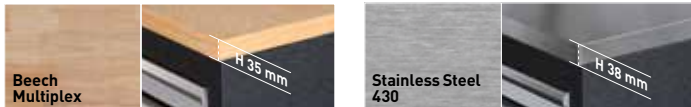

+ H 910 x B 1360 x T 463 mm

| Art. | Worktop | Thickness |
|---------------------|---------------------|-----------|
| 3964K-S500 | Beech Multiplex | 35 mm |
| 3964K-S500IX | Stainless Steel 430 | 38 mm |



+ H 910 x B 1360 x T 463 mm

| Art. | Worktop | Thickness |
|--------------------|---------------------|-----------|
| 3964K-940 | Beech Multiplex | 35 mm |
| 3964K-940IX | Stainless Steel 430 | 38 mm |



+ H 2000 x B 1360 x T 488 mm

| Art. | Worktop | Thickness |
|---------------------|---------------------|-----------|
| 3964K-S5-W | Beech Multiplex | 35 mm |
| 3964K-S5-WIX | Stainless Steel 430 | 38 mm |



+ H 2000 x B 1360 x T 488 mm

| Art. | Worktop | Thickness |
|----------------------|---------------------|-----------|
| 3964K-9S-K2 | Beech Multiplex | 35 mm |
| 3964K-9S-K2IX | Stainless Steel 430 | 38 mm |



+ H 2000 x B 1360 x T 488 mm

| Art. | Worktop | Thickness |
|---------------------|---------------------|-----------|
| 3964K-95K2 | Beech Multiplex | 35 mm |
| 3964K-95K2IX | Stainless Steel 430 | 38 mm |



+ H 2000 x B1 894 x B2 894 x T 488 mm

| Art. | Worktop | Thickness |
|--------------------|---------------------|-----------|
| 3964K-ECK | Beech Multiplex | 35 mm |
| 3964K-ECKIX | Stainless Steel 430 | 38 mm |

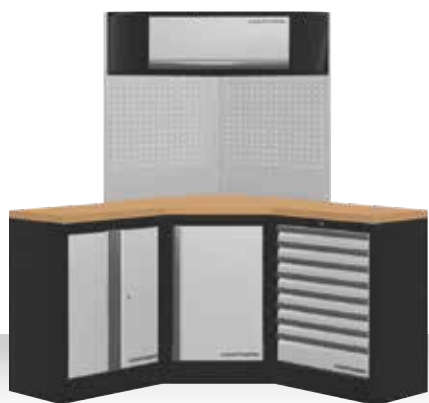

+ H 2000 x B1 1574 x B2 1574 x T 488 mm

| Art. | Worktop | Thickness |
|----------------|---------------------|-----------|
| 3964R | Beech Multiplex | 35 mm |
| 3964RIX | Stainless Steel 430 | 38 mm |



+ H 910 x B 2040 x T 463 mm

| Art. | Worktop | Thickness |
|--------------------|---------------------|-----------|
| 3964K-905 | Beech Multiplex | 35 mm |
| 3964K-905IX | Stainless Steel 430 | 38 mm |



+ H 910 x B 2040 x T 463 mm

| Art. | Worktop | Thickness |
|--------------------|---------------------|-----------|
| 3964K-4R8 | Beech Multiplex | 35 mm |
| 3964K-4R8IX | Stainless Steel 430 | 38 mm |



+ H 2000 x B 2040 x T 488 mm

| Art. | Worktop | Thickness |
|----------------------|---------------------|-----------|
| 3964K-80S-W | Beech Multiplex | 35 mm |
| 3964K-80S-WIX | Stainless Steel 430 | 38 mm |



+ H 2000 x B 2040 x T 488 mm

| Art. | Worktop | Thickness |
|----------------------|---------------------|-----------|
| 3964K-85S-W | Beech Multiplex | 35 mm |
| 3964K-85S-WIX | Stainless Steel 430 | 38 mm |



+ H 2000 x B 2040 x T 488 mm

| Art. | Worktop | Thickness |
|-----------------------|---------------------|-----------|
| 3964K-85S-K3 | Beech Multiplex | 35 mm |
| 3964K-85S-K3IX | Stainless Steel 430 | 38 mm |

Configurated Elements I empty



+ H 910 x B 2040 x T 463 mm

| Art. | Worktop | Thickness |
|---------------------|---------------------|-----------|
| 3964K-45S0 | Beech Multiplex | 35 mm |
| 3964K-45S0IX | Stainless Steel 430 | 38 mm |



+ H 2000 x B 2275 x T 463 mm

| Art. | Worktop | Thickness |
|---------------------|---------------------|-----------|
| 3964K-H25S | Beech Multiplex | 35 mm |
| 3964K-H25SIX | Stainless Steel 430 | 38 mm |



+ H 2000 x B 2640 x T 488 mm

| Art. | Worktop | Thick. |
|-------------------------|---------------------|--------|
| 3964K-H5R4-K1W | Beech Multiplex | 35 mm |
| 3964K-H5R4-K1WIX | Stainless Steel 430 | 38 mm |



+ H 2000 x B 2640 x T 463 mm

| Art. | Worktop | Thickness |
|---------------------|---------------------|-----------|
| 3964K-H504 | Beech Multiplex | 35 mm |
| 3964K-H504IX | Stainless Steel 430 | 38 mm |



+ H 2000 x B 2720 x T 488 mm

| Art. | Worktop | Thickness |
|------------------------|---------------------|-----------|
| 3964K-S854-K4 | Beech Multiplex | 35 mm |
| 3964K-S854-K4IX | Stainless Steel 430 | 38 mm |



+ H 2000 x B 3320 x T 488 mm

| Art. | Worktop | Thick. |
|-------------------------|---------------------|--------|
| 3964K-H5049-K4 | Beech Multiplex | 35 mm |
| 3964K-H5049-K4IX | Stainless Steel 430 | 38 mm |



+ H 2000 x B 3635 x T 488 mm

| Art. | Worktop | Thickness |
|----------------|---------------------|-----------|
| 3964H | Beech Multiplex | 35 mm |
| 3964HIX | Stainless Steel 430 | 38 mm |



+ H 2000 x B 4235 x T 488 mm

| Art. | Worktop | Thick. |
|---------------------------|---------------------|--------|
| 3964K-H284S5H-K4 | Beech Multiplex | 35 mm |
| 3964K-H284S5H-K4IX | Stainless Steel 430 | 38 mm |



+ H 2000 x B1 3849 x B2 2824 x T 488 mm

| Art. | Worktop | Thickness |
|----------------|-----------------|-----------|
| 3964E | Buche Multiplex | 35 mm |
| 3964EIX | Edelstahl 430 | 38 mm |



+ H 2000 x B1 2254 x B2 1574 x T 488 mm

| Art. | Worktop | Thickness |
|----------------|---------------------|-----------|
| 3964N | Beech Multiplex | 35 mm |
| 3964NIX | Stainless Steel 430 | 38 mm |

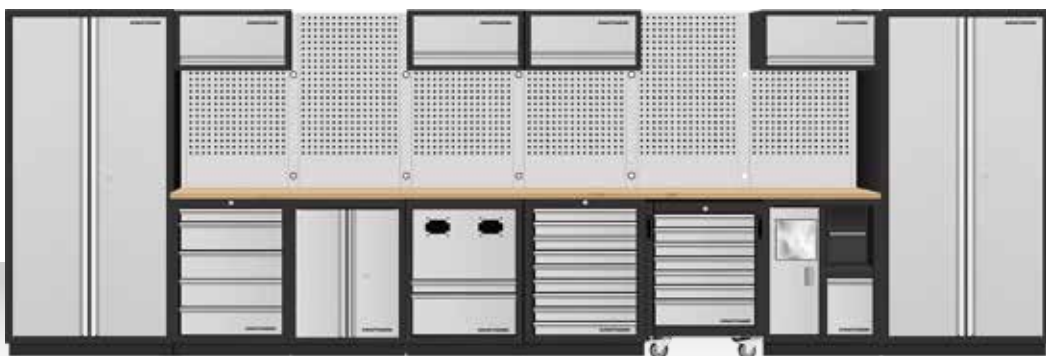

+ H 2000 x B 5910 x T 488 mm

| Art. | Worktop | Thickness |
|----------------|---------------------|-----------|
| 3964Q | Beech Multiplex | 35 mm |
| 3964QIX | Stainless Steel 430 | 38 mm |

Configured Elements | empty

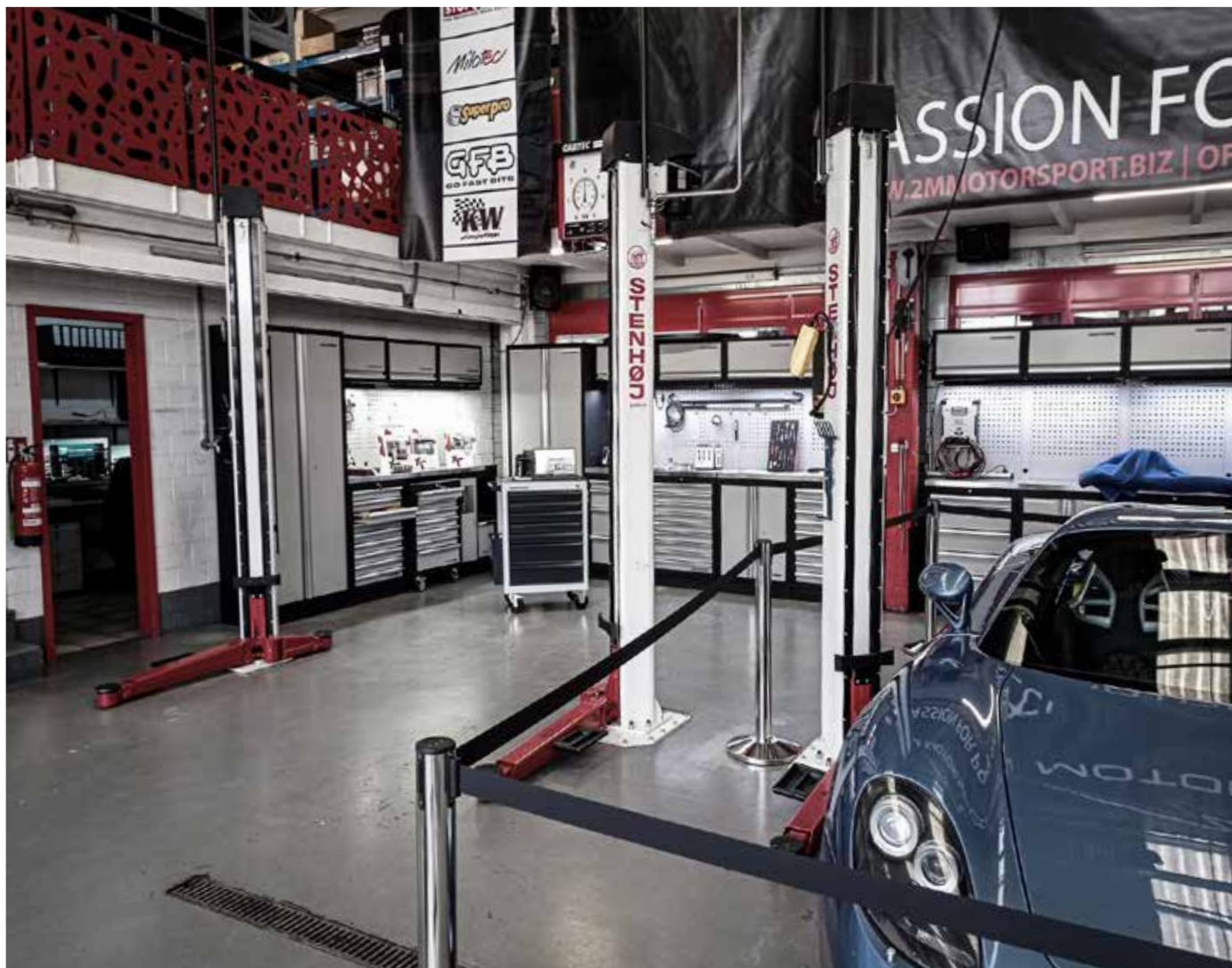

+ H 2000 x B 3635 x T 488 mm

| Art. | Worktop | Thickness |
|--------------|-----------------|-----------|
| 3964DIX-SANA | Beech Multiplex | 35 mm |

Worktop extension

To increase the depth of the worktop, all components are optionally available to extend our standard base units and thus increase variability.

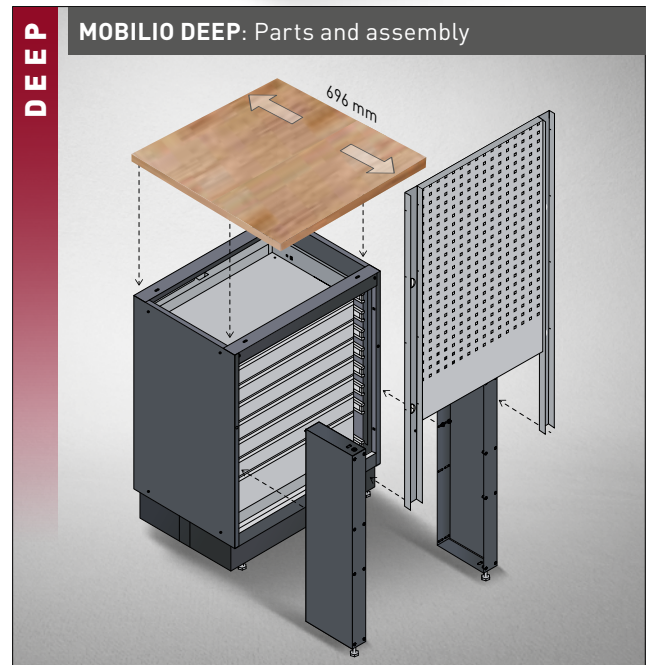
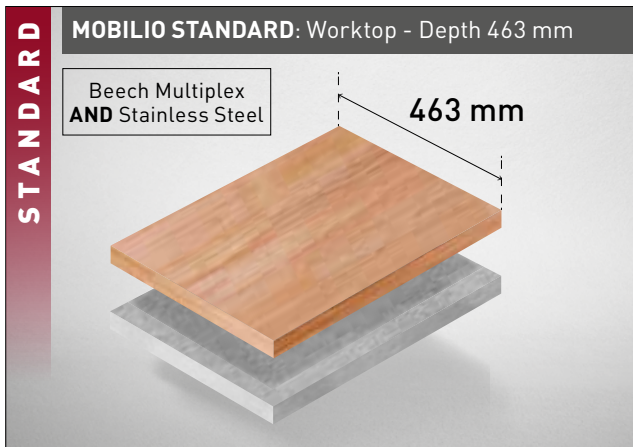













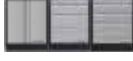

BEECH MULTIPLEX

- Made of several layers of peeled veneers (connected with an adhesive)
- Veneers are laid crosswise
- Material: beech wood
- High strength & dimensional stability
- Natural look

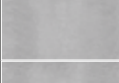

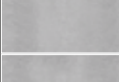

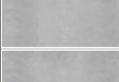
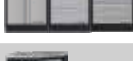

STAINLESS STEEL 430

- Density: 7.70 g/cm³
- Ferristic steel
- Chromium content of 17%
- Good corrosion resistance
- Good polishability
- Good resistance to water, water vapour, humidity
- Good resistance to weak acids and alkalis

WORKTOPS DEPTH 463 MM

| Art. | Material | | ± mm (H/B/T) | (Delivery without furniture element) | Δ kg |
|-------------------|---|----------------------------------|------------------------|---|-------|
| 3964-08 |  | For 1 Element | 35 × 680 × 463 |  | 8.53 |
| 3964-09 |  | For 2 Elements | 35 × 1361 × 463 |  | 17.18 |
| 3964-18 |  | For 3 Elements | 35 × 2050 × 463 |  | 24 |
| 3964-16-99 |  | For angular Element Art. 3964-16 | 35 × 864 × 463 |  | 19 |
| 3964-20 |  | For 1 Element | 38 × 680 × 463 |  | 10.5 |
| 3964-21 |  | For 2 Elements | 38 × 1361 × 463 |  | 21 |
| 3964-22 |  | For 3 Elements | 38 × 2041 × 463 |  | 31.8 |
| 3964-23 |  | For angular Element Art. 3964-16 | 38 × 865 × 463 |  | 17.8 |

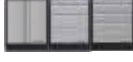
WORKTOPS DEPTH 696 MM

| Art. | Material | | ± mm (H/B/T) | (Delivery without furniture element) | Δ kg |
|--------------------|---|----------------------------------|------------------------|---|-------|
| 3964-088 |  | For 1 Element | 35 × 680 × 696 |  | 8.53 |
| 3964-099 |  | For 2 Elements | 35 × 1361 × 696 |  | 17.18 |
| 3964-188 |  | For 3 Elements | 35 × 2050 × 696 |  | 24 |
| 3964-16-999 |  | For angular Element Art. 3964-16 | 35 × 864 × 696 |  | 19 |

Inlays

Art. 4903-01

PRO LINE EVA Socket Set Insert 1/4", 46 pcs.

- 1/4" Ratchet
- 1/4" Sockets: 3.5 - 4 - 4.5 - 5 - 5.5 - 6 - 7 - 8 - 9 - 10 - 11 - 12 - 13 - 14 mm
- 1/4" Slotted Screwdriver Bit Sockets: 4 - 5.5 - 6.5 mm
- 1/4" PH Screwdriver Bit Sockets: PH1 - PH2 - PH3
- 1/4" PZ Bit Sockets: PZ1 - PZ2 - PZ3
- 1/4" TX Screwdriver Bit Sockets: T8 - T1 - T15 - T2 - T25 - T27 - T3 - T4
- 1/4" Hexagon Screwdriver Bit Sockets 3 - 4 - 5 - 6 - 7 - 8 mm
- 1/4" Bit Adapter
- 1/4" Universal Joint
- Extensions, 5, 10 mm
- 1/4" Flexible Extension: 15 mm
- Sliding Sliding Handle Adapter
- 1/4" Drive Handle
- 1/4" Bit Holder



Art. 4903-02

PRO LINE EVA Socket Set Insert 3/8", 32 pcs.

- 3/8" Ratchet
- Sockets: 8 - 9 - 10 - 11 - 12 - 13 - 14 - 15 - 16 - 17 - 18 - 19 - 21 - 22 - 24 mm
- 3/8" Deep Sockets: 10 - 11 - 12 - 13 - 14 - 15 - 17 - 19 mm
- 3/8" Spark Plug Sockets, 16 - 21 mm
- 3/8" Universal Joint
- Extensions, 75, 25 mm
- Sliding Handle Adapter, 1/2" to 3/8"
- Adapter, 3/8" to 1/4"
- Bit holder, 1/4" to 3/8"



Art. 4903-03

PRO LINE Socket Set Insert, 1/2", 22 pcs.

- 1/2" Ratchet
- Sockets: 10 - 11 - 12 - 13 - 14 - 15 - 16 - 17 - 18 - 19 - 21 - 22 - 24 - 27 - 3 - 32 - 34 mm
- Universal Universal Joint extensions, 125 - 25 mm
- Extensions, 125 - 25 mm
- Sliding Handle Adapter, 3/8" to 1/2"



Art. 4903-04

PRO LINE EVA Socket tray 1/2", 19 pcs.

- Sockets, 55 mm, hex 5 - 6 - 7 - 8 - 1 mm
- Sockets, 55 mm, spline M5 - M6 - M8 - M1 - M12
- Sockets, 1 mm, hex 6 - 7 - 8 - 1 - 12 mm
- Sockets, 1 mm, spline M5 - M6 - M8 - M1



Inlays

Art. 4903-05

PRO LINE EVA Socket and Socket tray 1/2", 19 pcs.

- Sockets, E-TX E1 - E12 - E14 - E16 - E18 - E2 - E22 - E24
- Sockets, 55 mm, TX T3 - T4 - T45 - T5 - T55 - T6
- Sockets, 1 mm, TX T3 - T4 - T45 - T5 - T55



Art. 4903-06

PRO LINE EVA Combination Spanner Insert, 12 pcs.

- Size: 8 - 9 - 10 - 11 - 12 - 13 - 14 - 15 - 16 - 17 - 18 - 19 mm
- DIN 3113 Form A, ISO 3318, ISO 7738
- Chrome Alloy Steel



Art. 4903-07

PRO LINE Combination Spanner Insert, 8 pcs.

- Size: 5.5 - 6 - 7 - 20 - 21 - 22 - 23 - 24 mm
- DIN 3113 Form A, ISO 3318, ISO 7738
- Chrome Alloy Steel



Art. 4903-08

PRO LINE Double Ended Ring Spanner Insert, 8 pcs.

- Size: 6 x 7 - 8 x 9 - 10 x 11 - 12 x 13 - 14 x 15 - 16 x 17 - 18 x 19 - 2 x 22 mm
- Offset 7° on both sides
- DIN 838, ISO 3318, ISO 185, ISO 114
- Chrome Alloy Steel



Inlays

Art. 4903-09

PRO LINE EVA Ergokraft Screwdriver Insert, 9 pcs.

- Slotted Screwdrivers .8 x 4 - 1. x 5 - 1.1 x 6 - 1.2 x 8 mm
- PH Screwdriver PH1 - PH2
- Stubby Slotted Screwdriver 1.1 x 6 mm
- Stubby PH Screwdriver PH2
- Voltage tester, 12 V DC
- With ergonomic handle



Art. 4903-12

PRO LINE EVA Circlip Pliers Insert, 4 pcs.

- Circlip Pliers: A2, A21, J2, J21
- For Circlips from Ø 19 - 6 mm



Art. 4903-13

PRO LINE EVA PRO LINE Striking Tool Insert, 11 pcs.

- German Engineer Hammer, hickory: 5 g
- Soft Face Hammer, hickory, 35 mm PU - nylon inserts: 36 g
- Flat Chisel, 18 - 22 mm
- Pin Punches, 2 - 3 - 4 - 5 - 6 - 8 mm
- Center Punch: No. 2



Art. 4903-15

PRO LINE EVA HIGHTECH Pliers Insert, 4 pcs.

- Combination Plier: 180 mm / 7"
- Diagonal Cutter, 160 mm / 6.1/4"
- Flat Round Plier: 205 mm / 8"
- Water Pump Plier: 240 mm / 9.1/2"



Inlays

Art. 4903-16

PRO LINE EVA Combination wrench tray Clickraft, 12 pcs.

- Ratcheting combination wrenches, 72 teeth, 8 - 9 - 10 - 11 - 12 - 13 - 14 - 15 - 16 - 17 - 18 mm
- Ratcheting combination wrench, 75 teeth, 19 mm
- Ratcheting angle 5°



Art. 4903-21

PRO LINE EVA Ballpoint T-screwdriver tray -Ergokraft, 7 pcs.

- Ball head T-handle screwdrivers, hex 3 - 4 - 5 - 6 - 7 - 8 - 10 mm



Art. 4903-22

PRO LINE T-Handle Wrenches Insert, 7 pcs.

- TX T-Handle Screwdriver: TX T10 - T15 - T20 - T25 - T27 - T30 - T40
- With ergonomic 2 component handle



Inlays

Art. 4903-23

PRO LINE Cutting Tool Insert, 18 pcs.

- ERGOKRAFT Snap-Off Knife: 9 mm
- Replacement Blades: 9 mm
- ERGOKRAFT Snap-Off Knife: 18 mm
- Replacement Blades: 18 mm
- Professional Hacksaw: 300 mm



Art. 4903-24

PRO LINE EVA Files tray Ergokraft, 11 pcs.

- Flat file, 320 mm
- Half round file, 320 mm
- Round file, 320 mm
- Square file, 320 mm
- Triangular file, 320 mm
- Needle file, flat - half round - round - square - triangular - knife



Art. 4903-25

PRO LINE Locking pliers/sheet metal shears insert, 4 pcs.

- ERGOKRAFT sheet metal shears, 250mm/ 10"
- Locking pliers 175 mm/ 7"
- Locking pliers 250 mm/ 10"
- Vise grip 150 mm/ 6"



Art. 4903-27

PRO LINE L-Key Wrenches Insert, 29 pcs.

- L-Key Wrenches, 1.5 - 2 - 2.5 - 3 - 4 - 5 - 6 - 7 - 8 - 10 mm
- TORX® L-Key Wrenches, T10 - T15 - T20 - T25 - T27 - T30 - T40 - T45 - T50
- TORX® L-Key Wrenches with hole, TS10 - TS15 - TS20 - TS25 - TS27 - TS30 - TS40 - TS45 - TS50
- Adjustable Wrench, 0-30 mm, 250 mm / 10"



Inlays

Art. 4903-28

PRO LINE EVA Plier/shear tray, 4 pcs.

- Pincers, 200 mm
- Cable stripper, 160 mm
- Cable stripper and crimping pliers Ergokraft
- Universal shears Ergokraft, 150 mm



Art. 4903-29

PRO LINE EVA Elbow milled open wrench tray, 13 pcs.

- Elbow milled open wrench, double-hex x hex
- 7 - 8 - 9 - 10 - 11 - 12 - 13 - 14 - 15 - 16 - 17 - 18 - 19 mm



Art. 4903-30

PRO LINE EVA Elbow milled open wrench tray, 4 pcs.

- Elbow milled open wrench, double-hex x hex, 20 - 21 - 22 - 24 mm



Art. 4903-31

PRO LINE EVA Elbow milled open wrench tray, 3 pcs.

- Elbow milled open wrench, double-hex x hex, 27 - 30 - 32 mm



Inlays

Art. 105.515.002

PRO LINE COMPLETO EVA Tool Assortment , 24 pcs.



| Art. | Inlays | |
|-------------|---------|--|
| 105.515.002 | 4903-06 | PRO LINE EVA Combination Spanner Insert, 12 pcs. |
| | 4903-07 | PRO LINE Combination Spanner Insert, 8 pcs. |
| | 4903-11 | PRO LINE EVA Pliers tray Ergokraft, 4 pcs. |

Art. 105.515.003

PRO LINE COMPLETO EVA Tool Assortment , 40 pcs.



| Art. | Inlays | |
|-------------|---------|---|
| 105.515.003 | 4903-13 | PRO LINE EVA PRO LINE Striking Tool Insert, 11 pcs. |
| | 4903-23 | PRO LINE Cutting Tool Insert, 18 pcs. |
| | 4903-24 | PRO LINE EVA Files tray Ergokraft, 11 pcs. |

Modular Workshop Elements | empty

To assemble according to your own needs. Free-standing construction, no fasteners necessary and therefore very flexible to set up. Each module can be ordered individually. Drawers with ball bearings in different heights, with central locking and individually lockable.

With our One-Key solution, it is possible to retrofit all locks with the same lock number so that only one key is needed.

Depending on the area of application, different worktop models can be selected depending on the application: Beech Multiplex/Wood | Stainless Steel 430.

Drawer dimensions from:

- 3964-04 (2C+1B+1A)
- 3964-05 (4B+1A)
- 3964-13 (9A)
- 3964-14 (7A+1B)
- 3964-15 (6A+1B)
- 3964-28 (1A+1C)

| | L1 (mm) | L2 (mm) | L3 (mm) |
|----------|---------|---------|---------|
| A | 560 | 404 | 58 |
| B | 560 | 404 | 138 |
| C | 560 | 404 | 207 |



| Art. | Dimension Weight |
|----------------|---------------------------------------|
| 3964-03 | H 910 x W 680 x D 458 mm ⚖️ 29.4 kg |



| Art. | Dimension Weight |
|----------------|---------------------------------------|
| 3964-04 | H 910 x W 680 x D 458 mm ⚖️ 46.7 kg |



| Art. | Dimension Weight |
|----------------|---------------------------------------|
| 3964-05 | H 910 x W 680 x D 458 mm ⚖️ 49.3 kg |

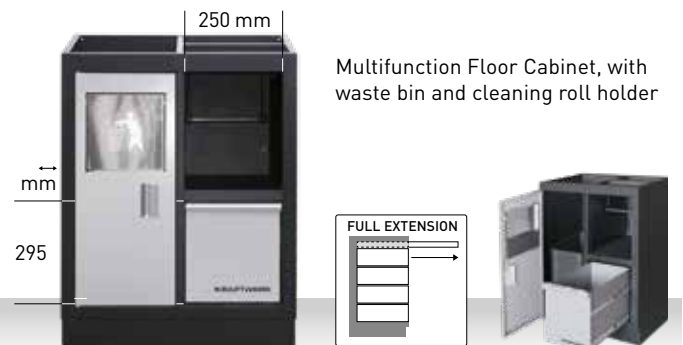

| Art. | Dimension Weight |
|----------------|-------------------------------------|
| 3964-11 | H 910 x W 680 x D 458 mm ⚖️ 37 kg |



| Art. | Dimension Weight |
|----------------|-------------------------------------|
| 3964-13 | H 910 x W 680 x D 458 mm ⚖️ 55 kg |



| Art. | Dimension Weight |
|----------------|---------------------------------------|
| 3964-14 | H 910 x W 680 x D 458 mm ⚖️ 52.5 kg |

Mobile Tool Cabinet,
7 ball-bearing drawers
with full extension

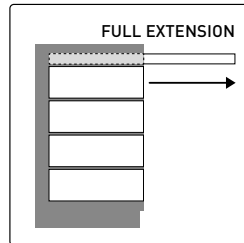
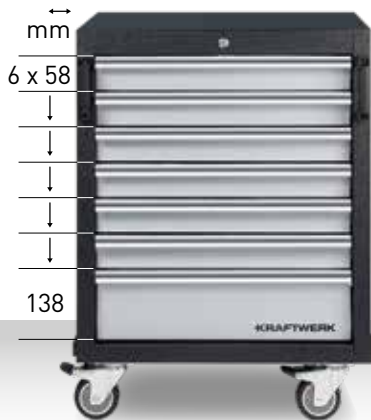

| Art. | Dimension Weight |
|----------------|------------------------------------|
| 3964-15 | H 646 x W 862 x D 458 mm ⚖ 51 kg |

Floor Cabinet, for cable and hose
reels, 2 ball-bearing drawers with
full extension

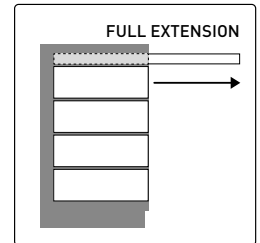
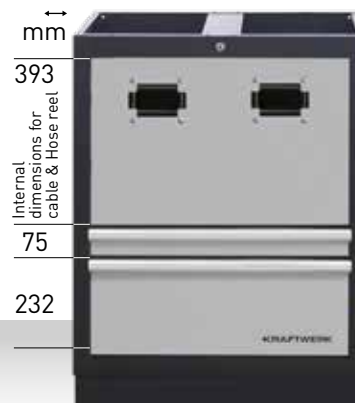

| Art. | Dimension Weight |
|----------------|------------------------------------|
| 3964-28 | H 910 x W 680 x D 458 mm ⚖ 40 kg |

Floor Cabinet,
1 door,
1 shelf included



| Art. | Dimension Weight |
|----------------|------------------------------------|
| 3964-16 | H 910 x W 864 x D 458 mm ⚖ 42 kg |

Corner Wall Cabinet,
1 door, with gas struts

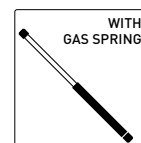

| Art. | Dimension Weight |
|----------------|------------------------------------|
| 3964-25 | H 350 x W 865 x D 281 mm ⚖ 21 kg |

Corner Wall Cabinet,
1 door, with gas struts

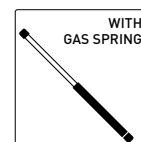

| Art. | Dimension Weight |
|----------------|------------------------------------|
| 3964-01 | H 350 x W 680 x D 281 mm ⚖ 10 kg |



Wall Cabinet
Tambour Front



| Art. | Dimension Weight |
|----------------|-------------------------------------|
| 3964-19 | H 350 x W 680 x D 281 mm ⚖ 8.4 kg |



Wall Cabinet, 2 doors,
1 shelf included



| Art. | Dimension Weight |
|----------------|------------------------------------|
| 3964-27 | H 680 x W 680 x D 300 mm ⚖ 16 kg |

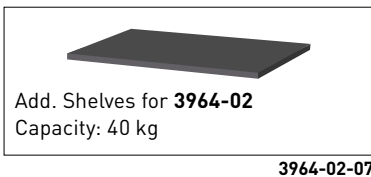

3964-02-07



Height Floor Cabinet
4 shelves included



| Art. | Dimension Weight |
|-------------------|-------------------------------------|
| 3964-02 | H 2000 x W 600 x D 458 mm ⚖ 53 kg |
| 3964-02-07 | H 20 x W 590 x D 430 mm ⚖ 0.30 kg |

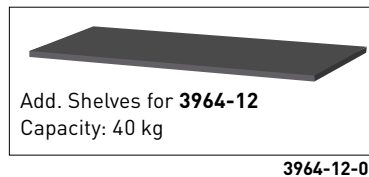

3964-12-01



Height Floor Cabinet,
2 doors,
4 shelves included



| Art. | Dimension Weight |
|-------------------|-------------------------------------|
| 3964-12 | H 2000 x W 915 x D 458 mm ⚖ 74 kg |
| 3964-12-01 | H 20 x W 905 x D 430 mm ⚖ 0.60 kg |

Modular Workshop Elements

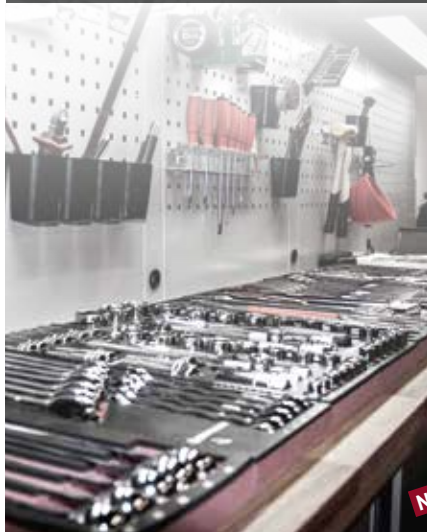

MOBILIO console for worktop extension **NEW**

Suitable for all Mobilio base units, can only be used in combination with extended worktops with a depth of 696 mm.
Powder-coated in matt black.
Scope of delivery 1 pc. - On/off switch

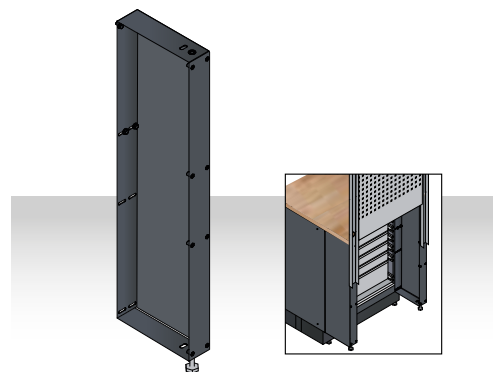

| Art. | Weight |
|--------------------|---------|
| NEW 3964-EX | ΔΔ 3 kg |

1
PC.

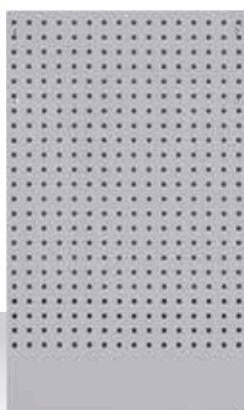

Perforated Back Panels

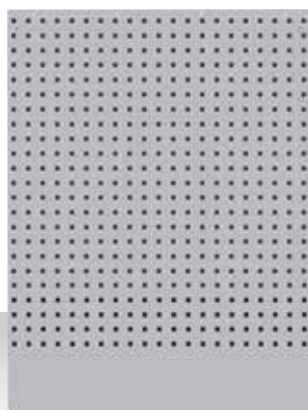

Perforated Back Panels for Art. 3964-16



| Art. | Dimension Weight |
|---------|--------------------------------------|
| 3964-29 | H 1052 x W 615 x D 24 mm ΔΔ 5.3 kg |
| 3964-30 | H 1052 x W 800 x D 24 mm ΔΔ 6.7 kg |

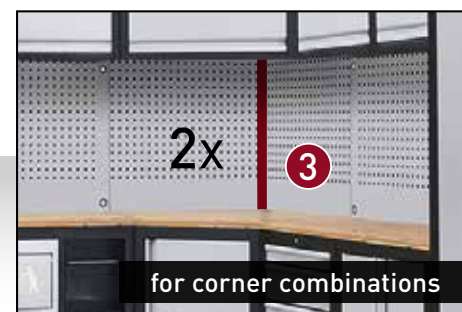

| Art. | Description |
|------------|---|
| 3964-03-07 | One-Key-Solution (lock 90°) for Art. 3964-02 3964-03 3964-12 3964-16 3964-27 |
| 3964-04-10 | One-Key-Solution (lock 180°) for Art. 3964-04 3964-05 3964-13 3964-14 3964-15 3964-28 |

| Art. | Description Dimension |
|---------------------|--|
| 3964-24 1 | MOBILIO Upright Connector for 2 Elements, H 1420 x W 65 x D 30 mm |
| 3964-07 2 | MOBILIO Upright Connector for 2 Elements, with cable holes H 1420 x W 65 x D 30 mm |
| 3964-10 3 | MOBILIO Single Upright Connector H 1420 x W 32.5 x D 30 mm |

Accessories for hanging panel



| Art. | Description Dimension Weight |
|--------|---|
| 2949-1 | Plastic magnetic bowl, red, Ø 150 mm ⚖ 360 g |
| 2949-2 | Plastic magnetic bowl, grey, Ø 150 mm ⚖ 360 g |
| 2949-3 | Plastic magnetic bowl, green, Ø 150 mm ⚖ 360 g |



| Art. | Description Dimension |
|------------|---|
| 3964-29-01 | Storage Tray for Cans H 100 x W 330 x D 100 mm |



| Art. | Description Dimension Weight |
|-------------|---|
| 145.111.035 | Single Tool Hook, vertical end 35 mm ⚖ 34 g |
| 145.111.070 | Single Tool Hook, vertical end 70 mm ⚖ 46 g |
| 145.111.135 | Single Tool Hook, vertical end 135 mm ⚖ 56 g |



| Art. | Description Dimension |
|------------|---|
| 3964-29-11 | Bracket for Plastic Box H 54 x W 440 x D 15.5 mm |



| Art. | Description Dimension Weight |
|-------------|---|
| 145.112.035 | Double Tool Hook, vertical end 35 mm ⚖ 76 g |
| 145.112.050 | Double Tool Hook, vertical end 50 mm ⚖ 90 g |
| 145.112.075 | Double Tool Hook, vertical end 75 mm ⚖ 90 g |
| 145.112.150 | Double Tool Hook, vertical end 150 mm ⚖ 98 g |



| Art. | Description Dimension |
|------------|---|
| 3964-29-14 | Plastic Box Blue H 75 x W 105 x D 140 mm |
| 3964-29-15 | Plastic Box Blue H 125 x W 140 x D 220 mm |
| 3964-29-16 | Plastic Box Blue H 125 x W 140 x D 270 mm |



| Art. | Description Dimension Weight |
|-------------|--|
| 145.125.035 | Pliers Tool Hook, W 35 x D 20 mm ⚖ 62 g |
| 145.125.075 | Pliers Tool Hook, W 75 x D 20 mm ⚖ 62 g |

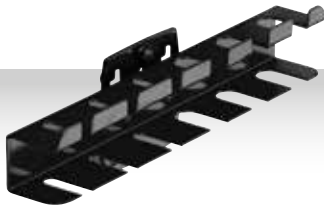

| Art. | Description Dimension Weight |
|-------------|---|
| 145.129.200 | Holder for 6 Screwdrivers W 200 x D 30 mm ⚖ 200 g |
| 145.129.390 | Holder for 12 Screwdrivers W 390 x D 30 mm ⚖ 400 g |

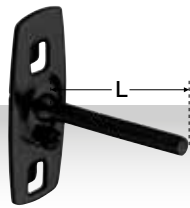

| Art. | Description Dimension Weight |
|-------------|--|
| 145.100.050 | Tool Hook, straight mandrial end L 50 mm Ø 6 mm ⚖ 34 g |
| 145.100.102 | Tool Hook, straight mandrial end L 102 mm Ø 6 mm ⚖ 46 g |
| 145.100.150 | Tool Hook, straight mandrial end L 150 mm Ø 6 mm ⚖ 56 g |

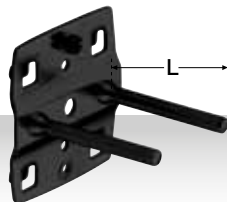

| Art. | Description Dimension Weight |
|-------------|---|
| 145.110.050 | Double Hook, straight mandrial end L 50 mm Ø 6 mm ⚖ 74 g |
| 145.110.102 | Double Hook, straight mandrial end L 102 mm Ø 6 mm ⚖ 98 g |
| 145.110.150 | Double Hook, straight mandrial end L 150 mm Ø 6 mm ⚖ 118 g |



| Art. | Description Dimension Weight |
|-------------|---|
| 145.121.040 | Inclined hook L1 15 x L2 35 mm Ø 6 mm ⚖ 34 g |



| Art. | Description Dimension Weight |
|-------------|--|
| 145.126.060 | Machine Tool Hook, Ø 60 mm ⚖ 72 g |
| 145.126.080 | Machine Tool Hook, Ø 80 mm ⚖ 80 g |



| Art. | Description Dimension Weight |
|-------------|--|
| 145.129.227 | Wrench Holder for 10 Spanners H 75-145 x D 220 mm ⚖ 480 g |



| Art. | Description Dimension Weight |
|-------------|--|
| 145.130.200 | Holder for 14 Drills each 2x Ø 3.0-4.2-6.5-7.5-8.5-16.5 mm each 1x Ø 10.5-12.5 mm W 200 x D 28 mm ⚖ 200 g |
| 145.130.390 | Holder for 28 Drills each 4x Ø 3.2-4.2-6.5-7.5-8.5-16.5 mm each 2x Ø 10.5-12.5 mm W 390 x D 28 mm ⚖ 400 g |

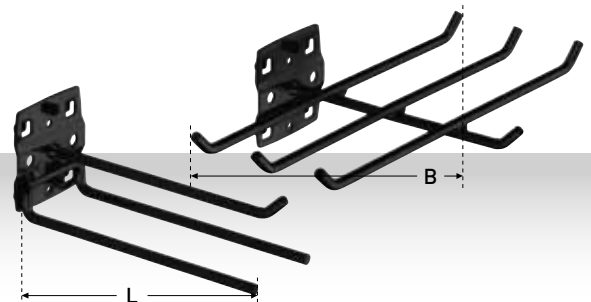

| Art. | Description Dimension Weight |
|-------------|--|
| 145.113.045 | Triple Tool Hook, 3-fold W 45 x L 150 mm Ø 6 mm ⚖ 170 g |
| 145.113.140 | Triple Tool Hook, 6-fold W 240 x L 140 mm Ø 6 mm ⚖ 256 g |

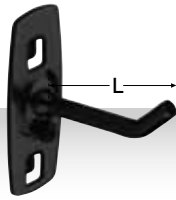

| Art. | Description Dimension Weight |
|-------------|---|
| 145.120.050 | Tool hook, inclined end L 50 mm Ø 6 mm ⚖ 34 g |
| 145.120.100 | Tool hook, inclined end L 100 mm Ø 6 mm ⚖ 46 g |
| 145.120.150 | Tool hook, inclined end L 150 mm Ø 6 mm ⚖ 56 g |
| 145.120.200 | Tool hook, inclined end L 200 mm Ø 6 mm ⚖ 68 g |

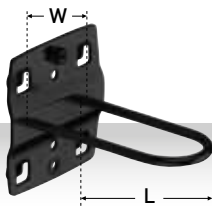

| Art. | Description Dimension Weight |
|-------------|---|
| 145.124.027 | Round Holder W 27 x L 65 mm ⚖ 68 g |



► Please order in pairs

| Art. | Description Dimension Weight |
|-------------|---|
| 145.127.060 | Pipe Holder W 35 mm Ø 60 mm ⚖ 114 g |
| 145.127.100 | Pipe Holder W 35 mm Ø 100 mm ⚖ 156 g |



| Art. | Description Dimension |
|-------------|--|
| 198.005.102 | Universal Container for hanging panel, 5 pcs. H 90 x W 75 x D 50 mm |



| Art. | Description Dimension Weight |
|-------------|--|
| 145.123.025 | Large tool clamp L 25 mm Ø 25 mm ⚖ 58 g |
| 145.123.028 | Large tool clamp L 28 mm Ø 28 mm ⚖ 60 g |
| 145.123.032 | Large tool clamp L 32 mm Ø 23 mm ⚖ 64 g |



| Art. | Description Dimension Weight |
|-------------|--------------------------------------|
| 145.122.006 | Small tool clamp Ø 6 mm ⚖ 24 g |
| 145.122.010 | Small tool clamp Ø 10 mm ⚖ 25 g |
| 145.122.013 | Small tool clamp Ø 13 mm ⚖ 26 g |
| 145.122.016 | Small tool clamp Ø 16 mm ⚖ 27 g |
| 145.122.019 | Small tool clamp Ø 19 mm ⚖ 28 g |

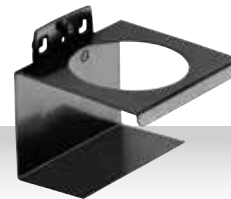

| Art. | Description Dimension Weight |
|-------------|---|
| 145.137.001 | Round Tool Holder W 100 mm Ø 70 mm ⚖ 200 g |



| Art. | Description Dimension Weight |
|-------------|---|
| 145.138.350 | Storage Plate W 350 x D 125 mm ⚖ 600 g |
| 145.138.445 | Storage Plate W 445 x D 150 mm ⚖ 900 g |



» Please order in pairs

| Art. | Description Dimension Weight |
|-------------|--|
| 145.128.080 | Saw Holder for 4 Saws W 52 x D 80 mm ⚖ 85 g |



| Art. | Description Dimension Weight |
|-------------|---|
| 145.131.200 | Hexagon Wrench Holder, for 9 Hexagon L-Key Wrenches W 200 x D 73 mm ⚖ 220 g |



| Art. | Description Dimension Weight |
|-------------|--|
| 145.135.150 | Combination Holder 2 pcs. W 60 x L 150 mm ⚖ 400 g |

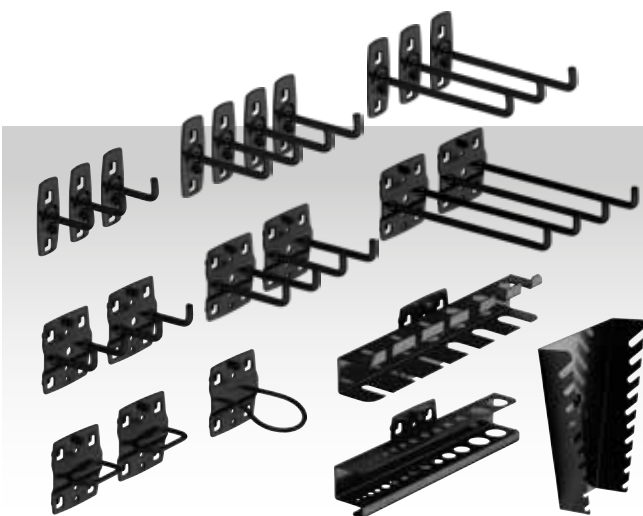

| Art. | Description |
|-------------|--------------------------|
| 145.100.900 | Tool Holder Set, 22 pcs. |



| Art. | Description Dimension Weight |
|-------------|--|
| 145.132.150 | Screwdriver Bit Holder for 7 Bits W 150 x D 35 mm ⚖ 200 g |



| Art. | Description Dimension Weight |
|-------------|---|
| 145.133.390 | Socket Holder for 12 Sockets W 390 x D 30 mm ⚖ 500 g |



| Art. | Description Dimension Weight |
|-------------|---|
| 145.134.340 | Tool Holder W 325 x H 55 x D 135 mm ⚖ 1100 g |



| Art. | Description |
|-------------|--|
| 145.100.800 | Feet for Mobilio M10 (4 pcs in 1 bag) |



Other accessories



LED Down Light

- Flexible use (magnet or U-Brackets)
- Connectable in series
- ON/OFF switch

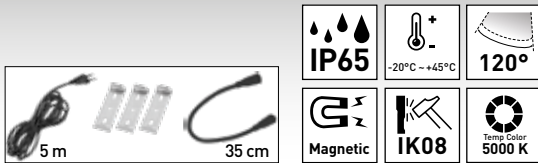

| Art. | Description Dimension Weight |
|-----------|---|
| 32077-60 | 20 W, 120 SMD, 1800 Lumens H 124 x W 590 x D 43 mm ⚖ 1.2 kg |
| 32077-120 | 40 W, 240 SMD, 3600 Lumens H 124 x W 1200 x D 43 mm ⚖ 2.3 kg |



Workbenches

- With height-adjustable feet
- 3 cm thick multiplex worktop, splash-proof, dirt-repellent and widely resistant to oil and grease
- Max. load-bearing capacity 150 kg

| Art. | Dimension Weight |
|------|--|
| 7526 | H min. 880 - max. 930 x W 1600 x D 600 mm ⚖ 54 kg |
| 7527 | H min. 880 - max. 930 x W 1600 x D 800 mm ⚖ 66 kg |



Automatic Air Horse Reel 15 + 1 m

- The housing can be swivelled up to 180°
- With automatic return spring and locking system
- Housing material: PP (Polypropylene)
- Reinforced hose made of hybrid polymer

| Art. | Dimension Weight |
|-------|--|
| 31041 | Fits for base cabinet 3964-28 (Page 17) H 370 x W 320 x D 180 mm ⚖ 5.5 kg |



Parallel Steel Bench Vise

- drop forged, with swivel base and tubular clamping jaw, exchangeable hardened clamping jaws, forward opening, with anvil and beak, black enameled.
- Jaws, guideway and anvil grinded and hardened.

| Art. | Dimension Weight |
|------|--|
| 2961 | L1 100 x L2 120 x L3 65 mm ⚖ 7.5 kg |
| 2962 | L1 125 x L2 140 x L3 70 mm ⚖ 11 kg |
| 2963 | L1 150 x L2 170 x L3 80 mm ⚖ 14.5 kg |
| 2964 | L1 200 x L2 200 x L3 90 mm ⚖ 20.5 kg |

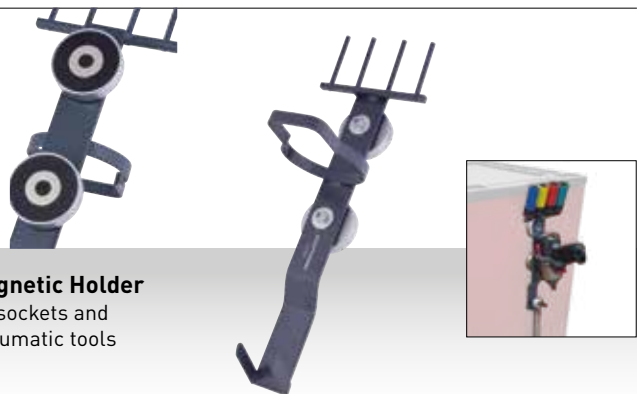

Magnetic Holder

- for sockets and pneumatic tools

| Art. | Dimension Weight |
|------|-------------------------------------|
| 3929 | H 400 x W 130 x D 150 mm ⚖ 2.1 kg |

Insert Bins

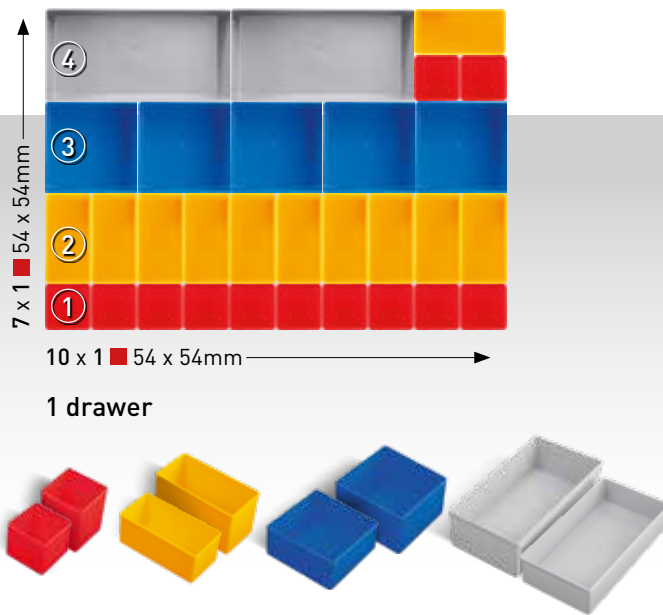

| Art. | Description Dimension |
|-------------|--|
| 198.000.018 | Insert Bin, Nr. 1 H 45 x W 54 x D 54 mm |
| 198.000.022 | Insert Bin, Nr. 1 H 63 x W 54 x D 54 mm |
| 198.000.019 | Insert Bin, Nr. 2 H 45 x W 108 x D 54 mm |
| 198.000.023 | Insert Bin, Nr. 2 H 63 x W 108 x D 54 mm |
| 198.000.020 | Insert Bin, Nr. 3 H 45 x W 108 x D 108 mm |
| 198.000.024 | Insert Bin, Nr. 3 H 63 x W 108 x D 108 mm |
| 198.000.021 | Insert Bin, Nr. 4 H 45 x W 108 x D 216 mm |
| 198.000.025 | Insert Bin, Nr. 4 H 63 x W 108 x D 216 mm |

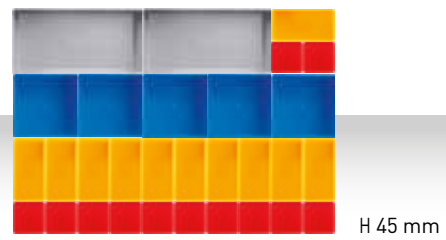

| Art. | Description |
|-------------|-------------------------|
| 198.001.001 | Insert Bin Set, 30 pcs. |



| Art. | Description |
|-------------|-------------------------|
| 198.001.002 | Insert bin set, 21 pcs. |



| Art. | Description |
|-------------|-------------------------|
| 198.001.003 | Insert Bin Set, 23 pcs. |

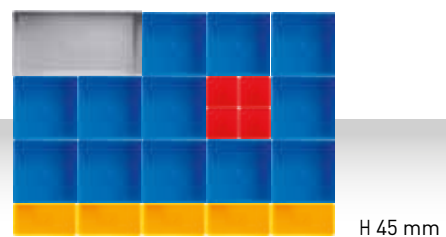

| Art. | Description |
|-------------|-------------------------|
| 198.001.004 | Insert Bin Set, 22 pcs. |



| Art. | Description |
|-------------|-------------------------|
| 198.001.005 | Insert Bin Set, 26 pcs. |

Accessories



| Art. | Description Dimension Weight |
|-------------|---|
| 145.143.010 | Paper Roll Holder, H 150 x W 300 x D 220 mm ⚖ 1.6 kg |



| Art. | Description Dimension Weight |
|-------------|---|
| 145.143.011 | Storage Compartment, H 60 x W 215 x D 85 mm ⚖ 0.5 kg |



| Art. | Description Dimension Weight |
|-------------|--|
| 145.143.012 | Storage Compartment for 8 Cabs, with handle, H 100 x W 300 x D 160 mm ⚖ 2.5 kg |



| Art. | Description Dimension Weight |
|-------------|---|
| 145.143.013 | Waste Paper Bin, H 300 x W 300 x D 160 mm ⚖ 3.5 kg |

KRAFTWERK Sink Set

Art. 150.500.002

Floor Cabinet with Stainless Steel Sink, Waste Garbage and Back Panel

- 1 x Art. 150.000.011 Sink
- 1 x Art. 808.100.101 Sanitizer
- 1 x Art. 808.100.102 Soap Dispenser
- 1 x Art. 808.100.201 Paper Roll
- 1 x Art. 808.100.301 Stainless Steel Panel
L 24 x W 615 x H 1052 mm | ⚖ 5.3 kg
- 1 x Art. 3964-03 MOBILIO Floor Cabinet, 2 doors,
1 shelf included
- 2 x Art. 3964-10 MOBILIO Single Upright Connector



Wash trough and tap + soap dispenser + sanitizer + paper towel dispenser + 2 door tool cabinet



Maximize and expand your hygiene in the workshop



Compact and easy to install



Touch free to optimize your workplace



Fits perfectly in Kraftwerk Mobilio range



Cabinet for hygiene spare parts



Accessories for Mobilio Sink

Also available individually

Art. 808.100.102

Touch Free Soap Dispenser

- Infrared sensor activity for non-touch operation
- Stainless Steel, 0,8 mm
- Capacity 0,8 liter

H 300 x W 105 x D 106 mm | ⚖ 1.38 kg



Art. 808.100.201

Centerfeed Paper Roll Box

- For paper rolls
- Stainless Steel, 0,8 mm
- Integrated tear-off edge for paper roll

H 339 x W 202 x D 215 mm | ⚖ 2.74 kg



Art. 808.100.101

Touch Free Sanitizer Dispenser

- Infrared sensor activity for non-touch operation
- Stainless Steel, 0,8 mm
- Capacity 0,8 liter

H 300 x W 112 x D 105 mm | ⚖ 1.38 kg

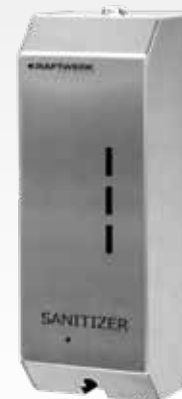



Art. 150.500.003

Floor Cabinet with Stainless Steel Sink

- 1 x Art. 150.000.011 Sink
- 1 x Art. 3964-29 Perforated Back Panel
H 1052 x W 615 x D 24 mm | ⚖ 5.3 kg
- 1 x Art. 3964-03 MOBILIO Floor Cabinet, 2 doors,
1 shelf included
- 2 x Art. 3964-10 MOBILIO Single Upright Connector



MOBILIO WEB CONFIGURATOR

**ACTUAL
HIGHEND 3D
MOBILIO WEB
CONFIGURATOR**

**best of
swiss
web**
usability
marketing
digital commerce
bronze 2019

Visit us on our homepage at mobilio-configurator.kraftwerktools.com

Subject to changes of specifications,
prices and availability.
Valid from **01.03.2024** to **31.01.2025**

Prices in € excl. V.A.T

Distribution: KRAFTWERK Group AG
export@kraftwerktools.com

Your specialized dealer: